

SPECIFICATIONS

ELECTRICAL

Current dissipation : 95 mA
 Power Consumption : 1.10W White, 0.80W Colors
 Operating power : 12VDC Constant Voltage
 Maximum serial connection : 50 modules
 PWM dimming control supported

THERMAL

Cooling : Ambient air
 Maximum operating temperature : 140°F (60°C)
 Minimum operating temperature : -13°F (-25°C)
 Maximum storage temperature : 140°F (60°C)
 Minimum storage temperature : -22° F (-30°C)



PHYSICAL

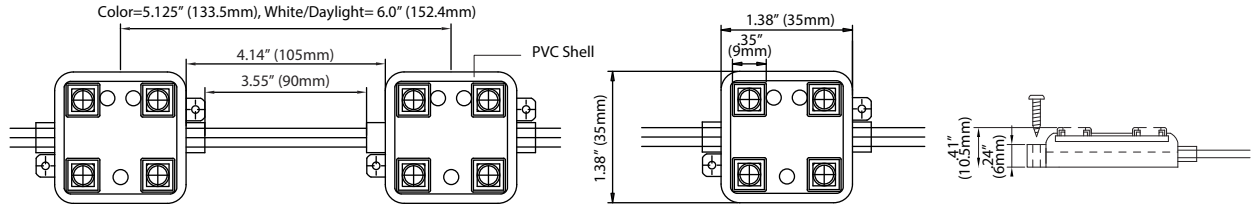

PRECAUTIONS

Use precautions to avoid damages to the product or injuries of users. Any actions against following contents can cause serious issues such as malfunction, electric shock, or burn.



USE DC 12V INPUT ONLY!



DO NOT USE AC INPUT!



Do not cut or rejoin wires while product is connected with live power source



Avoid performing installation under rain or high humidity and only install in temperatures above 50°F (10°C) to allow for better mounting tape adhesion



Do not use the product under any of the circumstances listed below:
 - High temperature locations over 140°F (60°C)
 - Spots with extreme moisture or dust
 - Places that have corrosive gas or have highly concentrated electromagnetic fields



Do not perform actions listed below:
 - Alter or modify Modules
 - Touch LED lamps with sharp objects
 - Put glue or silicon over the LED lamps



Maximum driver quantity per serial connection is limited to available power supply wattage, failure causes overload of current and damages to the product



Refer to 'WIRE THICKNESS' table to use proper wire thickness between 12V power supply and the first LED Module. Failure will cause dimmed output.



Cable length between power supply and the first LED module is limited. Refer to 'CONNECTION WITH POWER SUPPLY' on page 2

PREPARATION

TOOLS REQUIRED

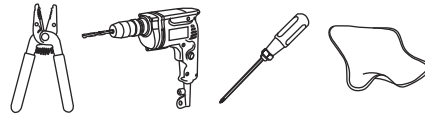

Wire Stripper, Drill, Screw Driver, towel or rag.

SUPPLIES REQUIRED

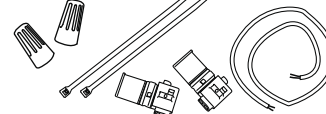

Wire Nuts, Cable Ties, IDC Connectors, Wire (Optional : Screws)

PREPARE CHANNEL LETTERS

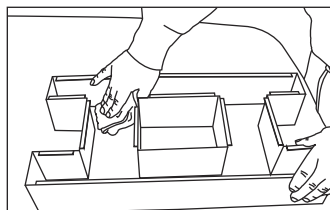

1. Clean moisture , dust and oil from the inside of letter using Rubbing Alcohol for best adhesion of mounting tape

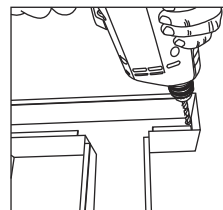

2. Drill a hole for power wire

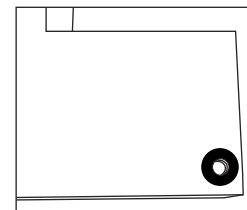

3. Use bushing to protect incoming wires from sharp edge of Channel Letter

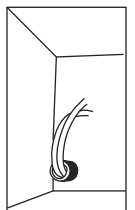

*Use only white paint inside the channels for better reflection

LAYOUT DENSITY GUIDELINES

Use recommended length for pitch between each module to achieve optimum lighting output while maintaining lowest unit cost. Failure or misplacing will cause dimmed spots or uneven appearance of light on the surface. 3 inches minimum depth.

RECOMMENDED PITCH PER DEPTH

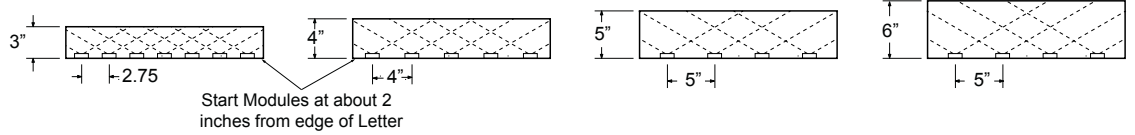

RECOMMENDED LAYOUT DENSITY PER CHANNEL WIDTH

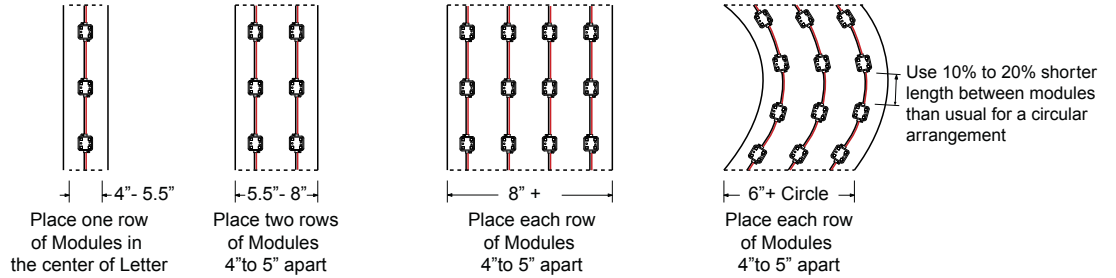

CONNECTION GUIDE

Maximum driver quantity per serial connection is limited. Using more quantity per run will cause overload from Power Supply which damages all connected products. This will cause voltage drop and also dimmed lighting output.

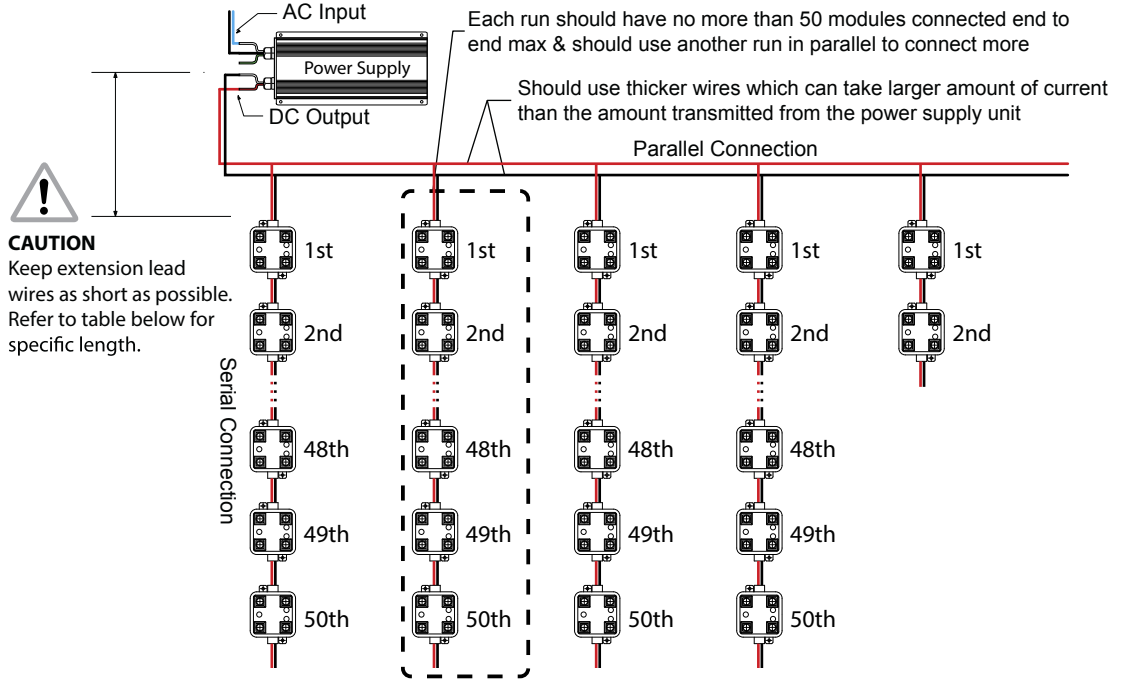

CONNECTION WITH POWER SUPPLY

SUPER NOVA 4 - MODULES PER WATTS OF POWER & EXTENSION OF LEAD WIRES FROM POWER SUPPLY

Output (W)	20W	40W	60W	120W
Output (A)	1.7A	3.4A	5A	10A
Max Module Quantity - White*	16 pcs	32 pcs	47 pcs	95 pcs
Max Module Quantity - Colors*	23 pcs	45 pcs	69 pcs	138 pcs
Recommended Extension Wire	AWG18	AWG18	AWG18	AWG18
Maximum Length Serial Connection	25FT (7.62M)	25FT (7.62M)	25FT (7.62M)	25FT (7.62M)

*Maximum quantity for Super Nova 4 is based on approximately 90% of specified capacity of power supplies for extended lifespan. Equip with protective box for outdoor use and the box should have ventilating holes

INSTALLATION GUIDE

1. DETERMINE LAYOUT

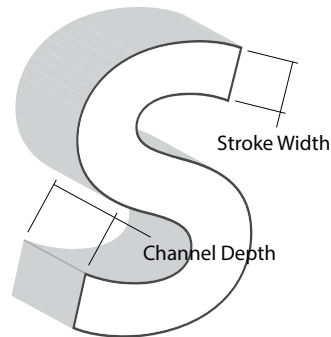

Refer to 'LAYOUT DENSITY GUIDELINES' on page 2 to determine spacing and amount of LEDs required.

2. PEEL AND STICK

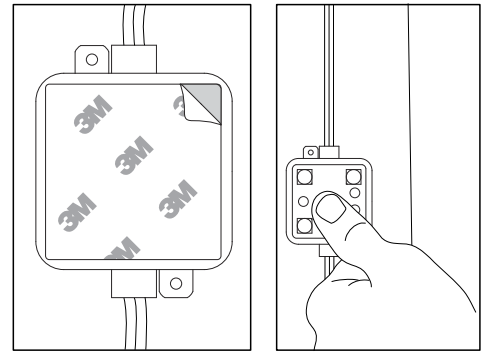

Remove 3M™ VHB™ tape on the back of modules and stick them into place. Make sure modules are firmly attached to the surface.



CAUTION

When handling the module, avoid pressing down directly on top of LED lamp

3. CAP ALL UNUSED WIRES

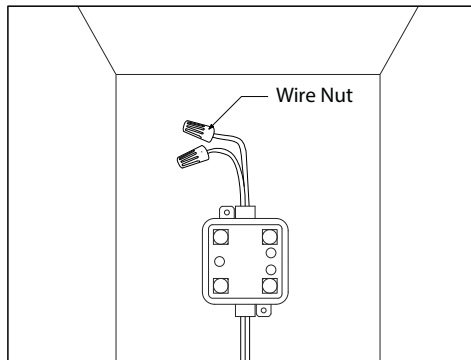

Protect the wire ends of the strand of modules should not be looped to create a closed circuit.

4. CONNECT WITH POWER SUPPLY

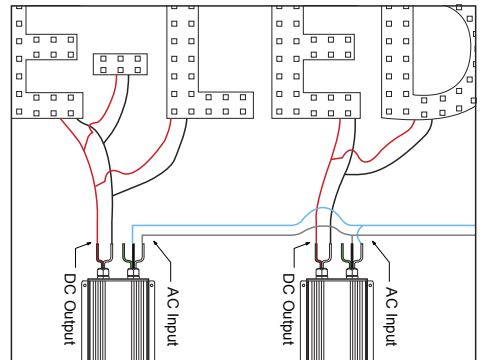

Using predetermined layout and LED placement from step 1, divide channels into sections and distribute each section to corresponding power supplies.



CAUTION

Before connect with power supplies, check polarity on every connections

5. FIX MODULES PERMANENTLY

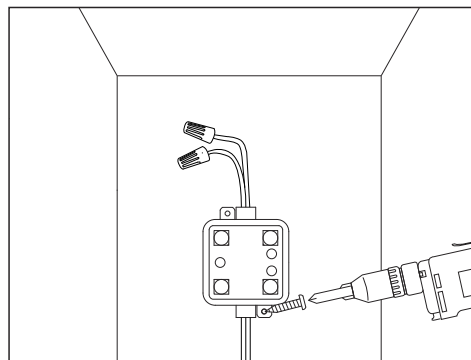

FASTENERS: If desired, modules can be secured with #4 X 1/2" metal screws.

TROUBLE SHOOTING

Entire sign or leg does not light after complete installation.	Check connection from power supply lead to first module. Make sure polarity of connections made at the power supply lead and any jumper wire is correct. Power supply outputs should be connected red-to-red and white-to-white.
Still does not light.	Check output voltage of power supply using a voltmeter. The output voltage should be 12VDC ± 0.5VDC. If there is no output voltage, have a licensed electrician check input voltage. Make sure power supply is connected correctly and getting primary power. Probably AC input wire is connected to ground terminal of power supply. If power supply is connected properly and getting primary power and there is still no output voltage, try a different power supply.
Still does not light.	If power supply is getting primary power and the modules do not light, there may be a short in the secondary wiring. Check all connections and cap all loose wires.
Beginning of a leg lights, but the entire leg does not light or lights intermittently.	The primary cause for a portion of a module leg not lighting or lighting intermittently is a bad connection or reverse polarity connection between the modules that light and the modules that don't light. Check this connection.
One module does not light, but all others in the leg light.	Super Nova Modules are designed so if one fails it will not cause the entire sign or leg to go out. If one module does not light, but all others in the leg do, replace the unlit module.
All modules light, but some of them are dimmed.	Check that each run has no more than the maximum number of modules. Also, check that the type of extension wire from the power supply to the first module is correct. If wires are not thick enough to transmit current from the power supply, this will cause a voltage drop and will dim the modules at the end.
Dark spots or dimmed spots occur.	Channel depth is too low, or center distance between modules is too far. Refer to 'LAYOUT DENSITY GUIDELINES' for more information.
Still has spots.	Covering acrylic is not intended for LED illumination. Use light diffusing acrylic sheets which are specially made for LED light source.